

# TRUSTILE<sup>®</sup> DOORS INC

The MDF Door With The Hardwood Edge™

Interior & Exterior  
MDF Doors

[www.trustile.com](http://www.trustile.com)

*NO LIMITS!!!*



*...And Still The Shortest Lead Time In The Industry™*

NO LIMITS!



TruStile Doors offers unlimited styles and options to fit all your door needs.

# Welcome to TruStile Doors, Inc.

In 1995, our company was founded to bring you a superior paintable door with unlimited design options. Our goal is to provide custom doors and products built to meet your specifications, schedule and budget. We promise to maintain impeccable workmanship, superior strength, durability and beauty that will last a lifetime. We back our goal with state-of-the-art manufacturing techniques combined with great attention to detail, exceptional customer service and our Limited Lifetime Warranty.

## Superior Materials

If you are painting your doors, choose one of our solid MDF doors.

- MDF is more stable than wood.
- MDF is environmentally friendly.
- MDF won't shrink, expand or warp like wood.
- MDF panels won't shrink or crack.
- MDF doors cost less than wood doors.
- MDF provides a smoother surface for painting.

Available for both interior and exterior applications, our doors come in over 300 different designs to fit your exact needs.

## Superior Manufacturing

### Built To Any Size

At TruStile, we can make just about any size and design you can think of. You are not limited to "standard sizes," because for us, any size is standard. With our unique manufacturing process, we build each door, one at a time, to your specifications. Instead of cutting down a "standard" door to make it a custom size, we build each door parametrically, to your exact measurements. With a TruStile door, you won't pay more for a door that has been created to your unique size.

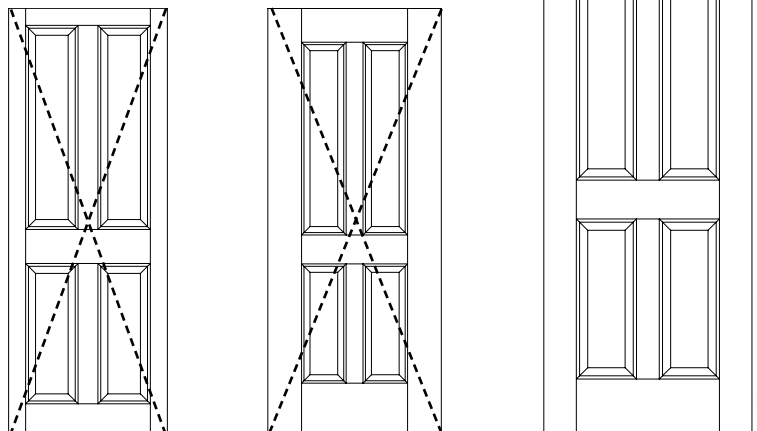

We don't trim from or add to the perimeter to make a door smaller or larger. We build our doors parametrically, the TruStile way.

## Construction

We use true stile and rail construction with The Wedge®, our hardwood edge system, in all of our MDF doors.

The Wedge® provides:

- Increased rigidity.
- Better screw holding.
- Quick and easy handling and installation.
- Easier chiseling for radius/square corner hardware.

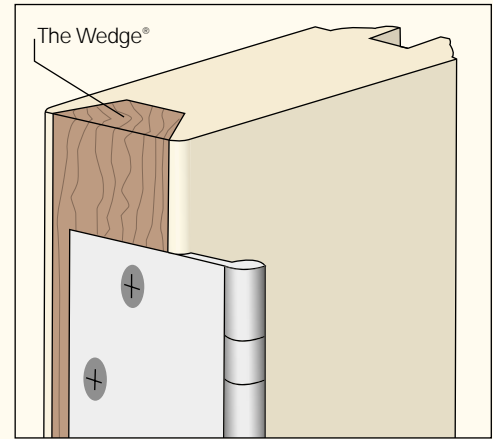
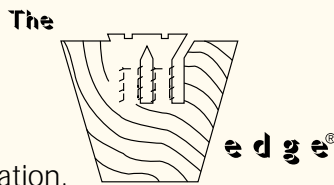

## Exterior MDF Doors

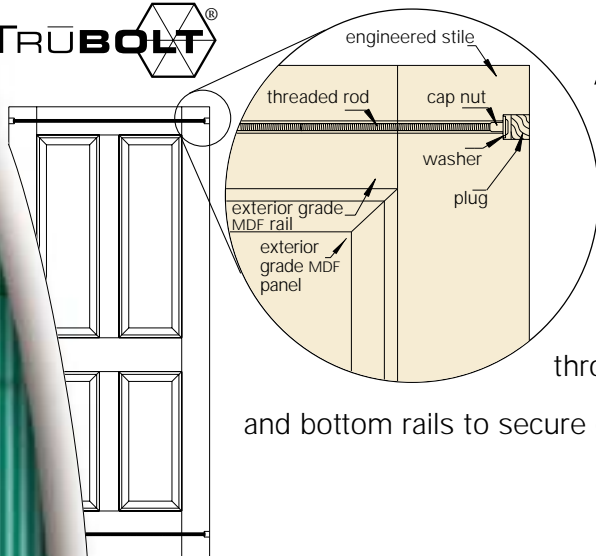

All of our exterior MDF doors are built with exterior grade MDF and our exclusive TruBOLT® system. We use a through bolt in both top and bottom rails to secure each exterior door.



TS4140 Exterior

## Superior Product

- True stile & rail construction.
- Limitless design possibilities.
- Increased rigidity with The Wedge®.
- Superior sound deadening properties.
- Custom designs welcome.
- Excellent customer service.
- Available in any size up to 4' X 8'.
- More depth than routed or stamped doors.

## Superior Service

- Short Lead-Times: Ninety-five percent of all jobpacks are shipped in one week.
- Ready to assist Account Managers.

Our TS Series offers panel doors with as few as one panel or as many as nine. Choose a door with straight panels for a Craftsman style or curved panels for a more contemporary look. There are no limits to what your door can look like.

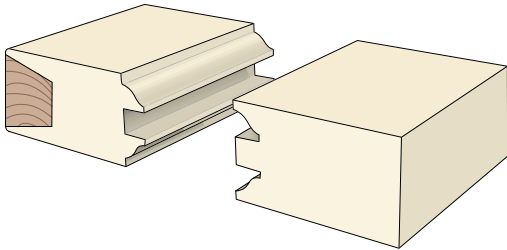

OG Cope and Stick

We manufacture our doors with true stile and rail construction giving you the option of rearranging components to create the style you're looking for.

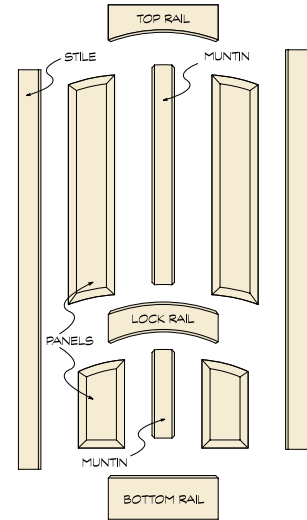

## Panel & Sticking Combinations

Our TS doors come standard with OG sticking and an "A" panel or you can choose a combination from our panel and sticking options illustrated below.

Mix and match any of the sticking and panel options below to customize your door.

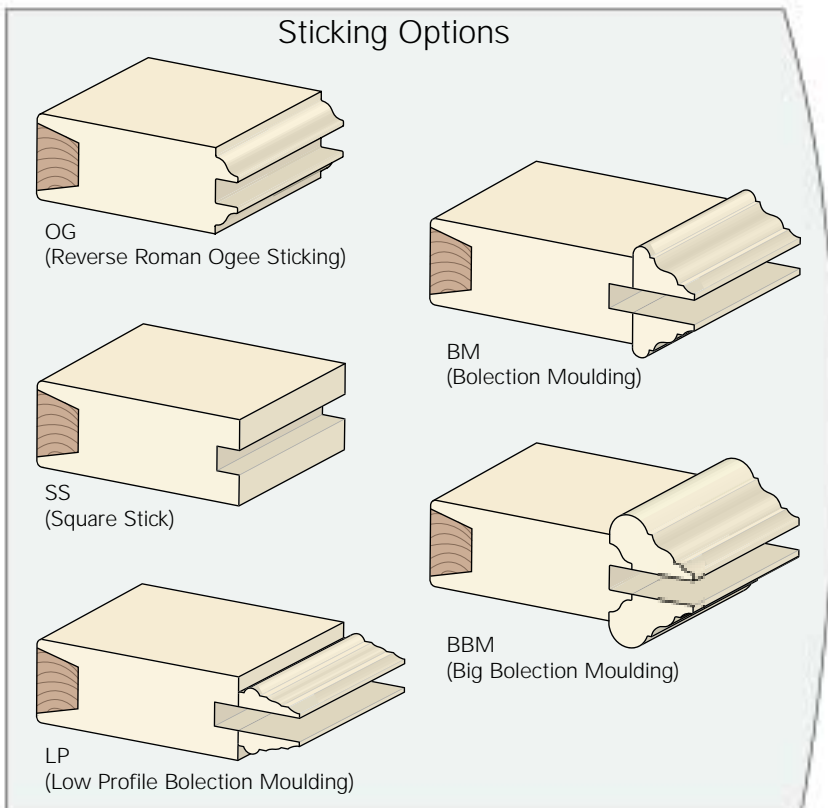

## Panel Options

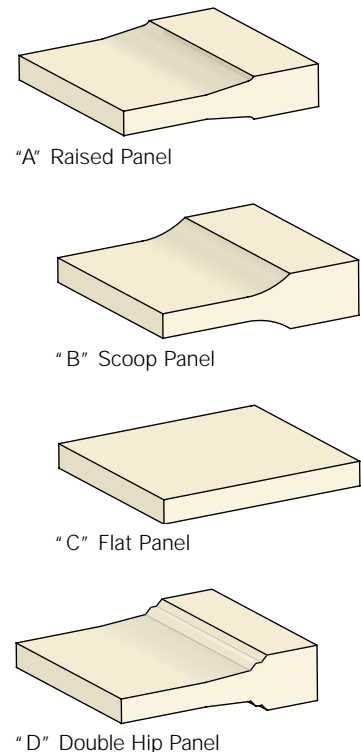

# TS Door Styles

Style Widths (face dimensions):  
 OG: 4" on doors 30" and under; 5" on doors over 30"  
 SS/LP/BM/BBM: 4-1/2"

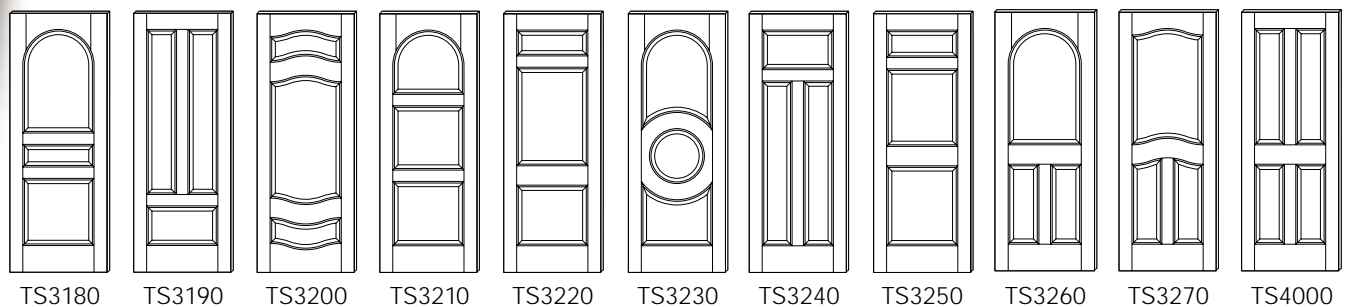
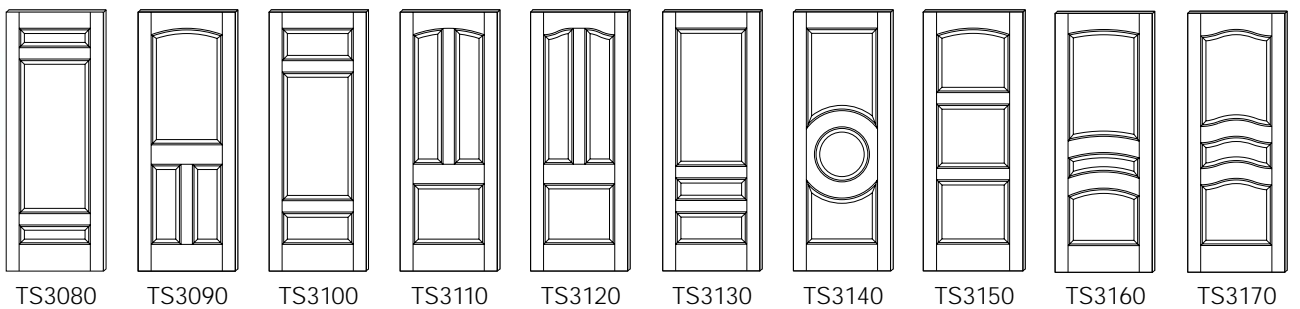
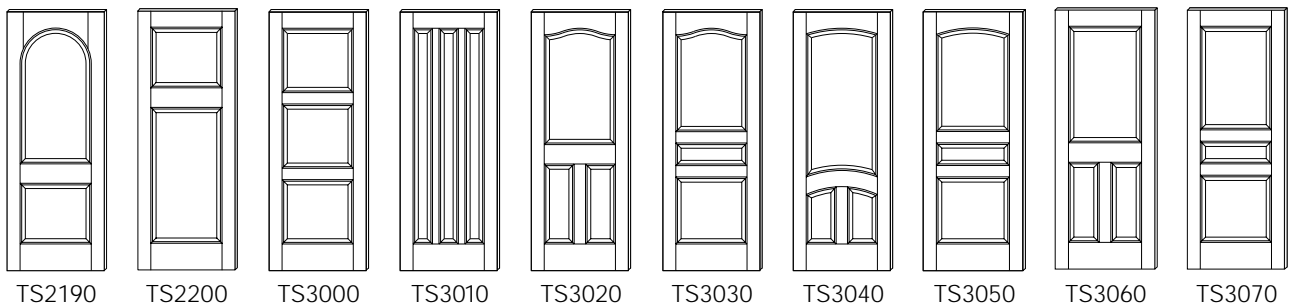
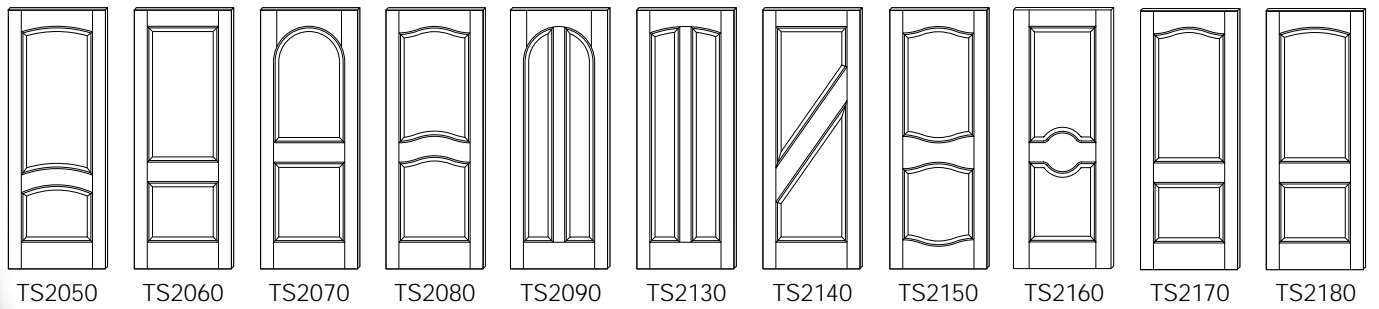
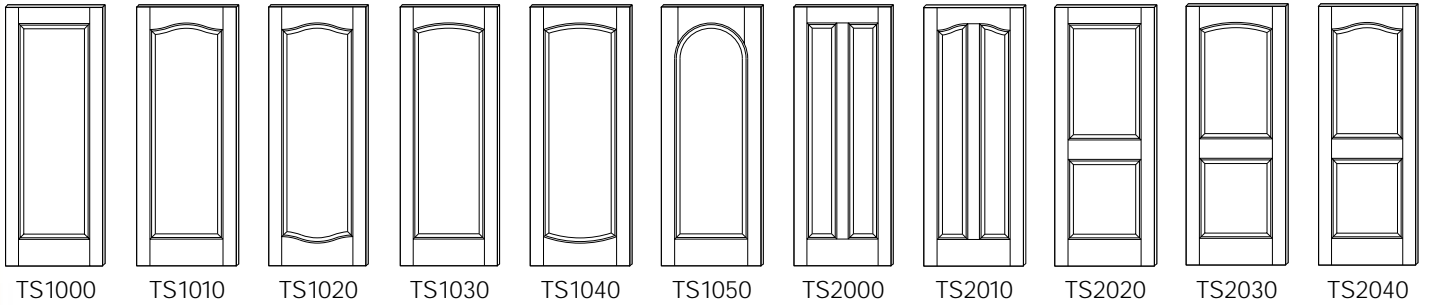

# TS Door Styles

Stile Widths (face dimensions):  
 OG: 4" on doors 30" and under; 5" on doors over 30"  
 SS/LP/BM/BBM: 4-1/2"

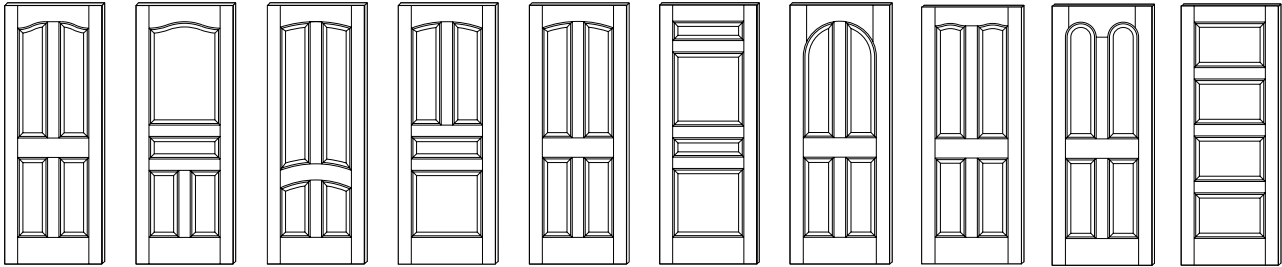

TS4010 TS4020 TS4030 TS4040 TS4050 TS4060 TS4070 TS4080 TS4090 TS4100

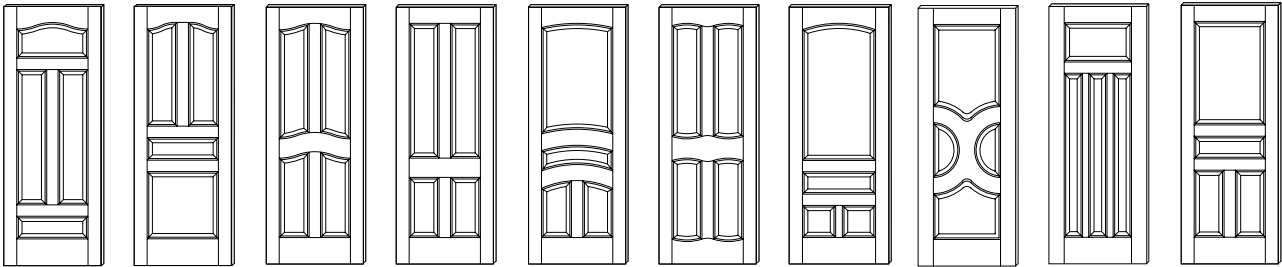

TS4110 TS4120 TS4130 TS4140 TS4150 TS4160 TS4170 TS4180 TS4190 TS4200

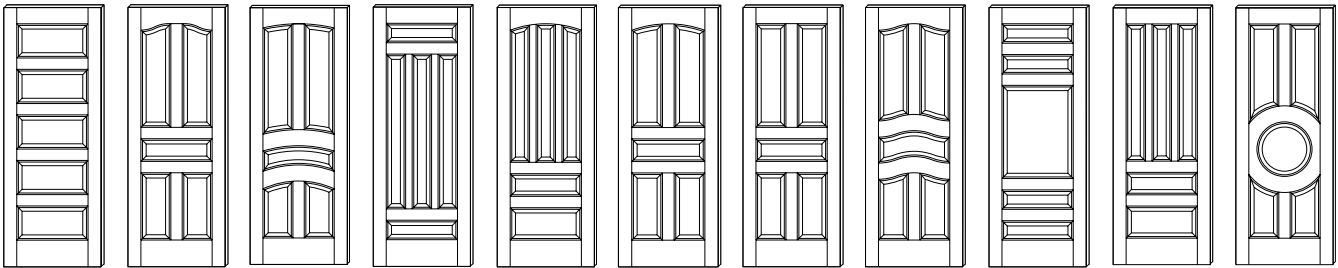

TS5000 TS5010 TS5020 TS5030 TS5040 TS5050 TS5060 TS5070 TS5080 TS5090 TS5100

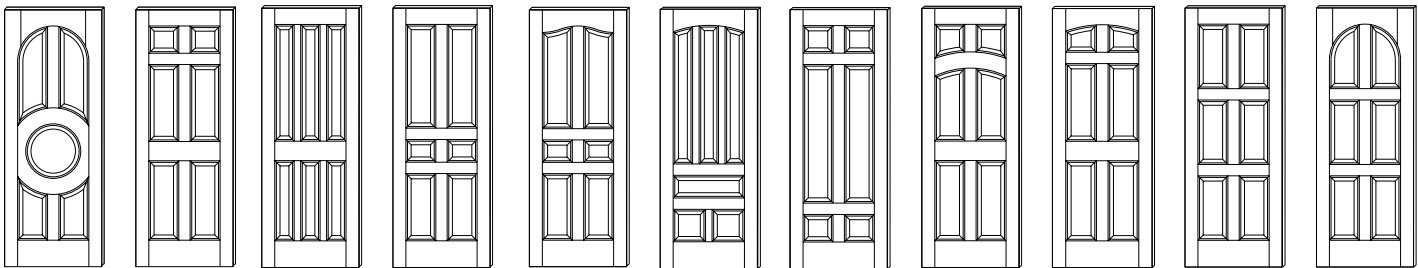

TS5110 TS6000 TS6010 TS6020 TS6030 TS6040 TS6050 TS6060 TS6070 TS6080 TS6090

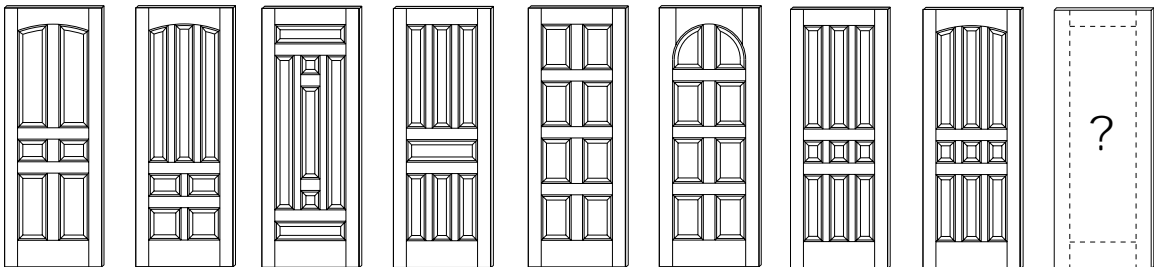

TS6100 TS7000 TS7010 TS7020 TS8000 TS8010 TS9000 TS9010 Custom

# FL Series

Add a touch of elegance with one of our over 90 different glass doors. All of our French Doors come standard with 1/4" clear safety glass or are available with art glass, custom etched patterns and a variety of sticking options.

**NOTE:** Our French Doors come with a protective film to protect each lite. The film peels off easily after the door has been completely finished.

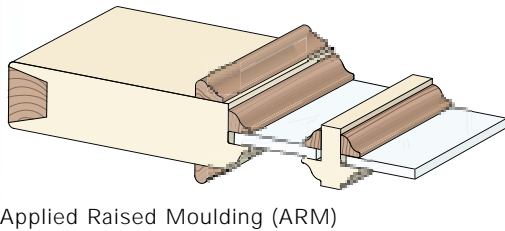
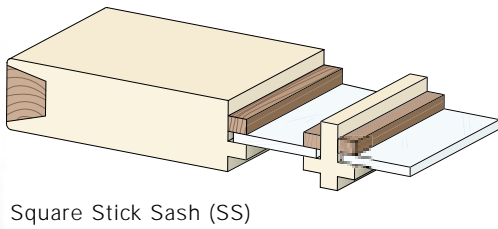
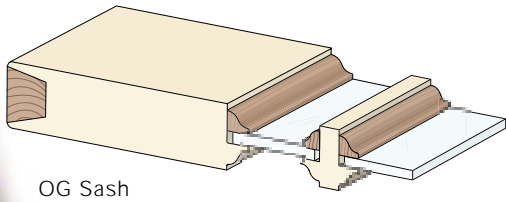
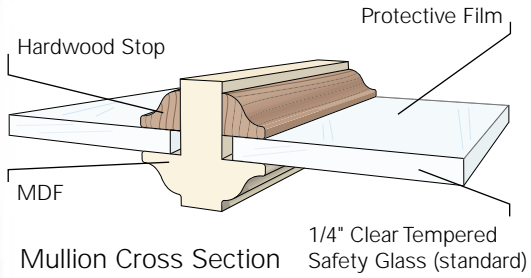

## Glass Options



BEVELED



OCEANIC



REED



SINGLE GLUE CHIP



VELVEX

## Custom Etched & Frosted Glass

We offer custom etched glass in any size and door design. You can choose from one of our standard patterns below or send us your own sketch and let us bring it to life on our CAD system.



TruCLAD® 1 Lite Logos and Custom Designs Available



Please specify clear pattern on frosted glass or frosted pattern on clear glass.

# FL Door Styles

Stile Widths (face dimensions):  
 OG/SS: 4" on doors 30" and under; 5" on doors over 30"  
 ARM: 5"

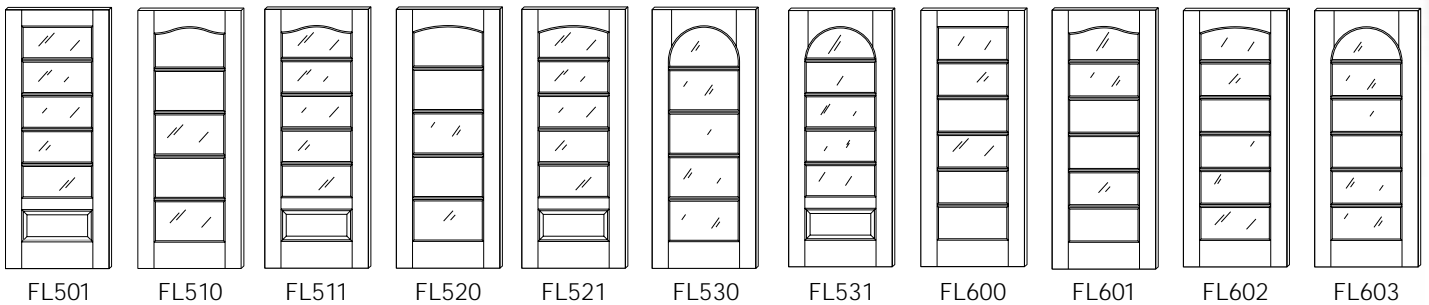
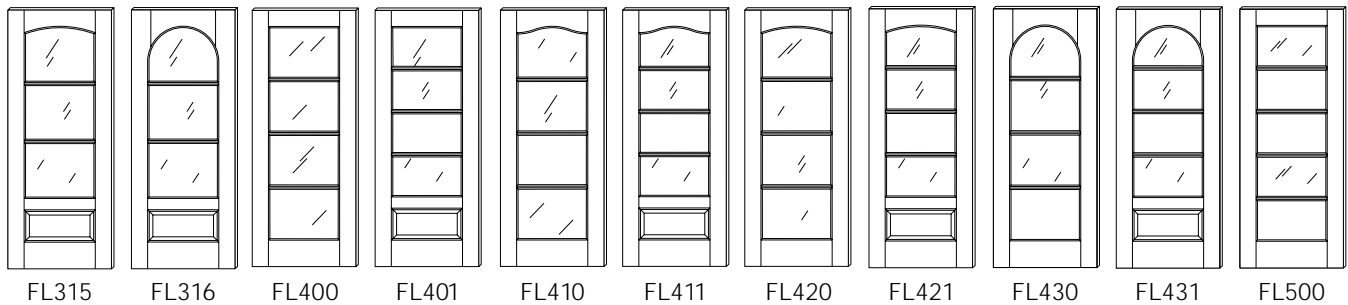
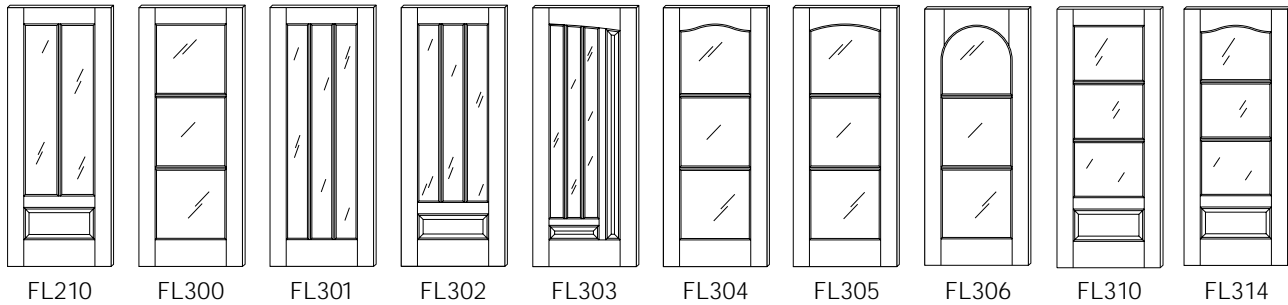
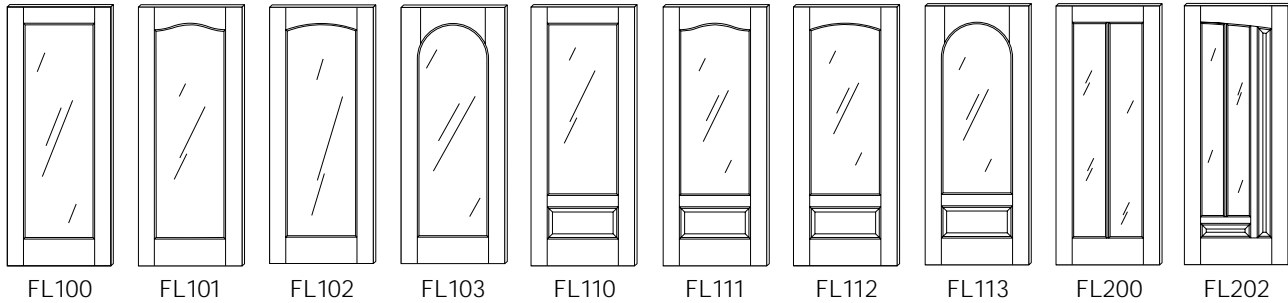

OBSCURE 62

RAIN

DOUBLE GLUE CHIP

FROSTED

WHITE LAMI

# FL Door Styles

Stile Widths (face dimensions):  
 OG/SS: 4" on doors 30" and under; 5" on doors over 30"  
 ARM: 5"



FL606 FL607 FL608 FL609 FL616 FL617 FL618 FL619 FL800 FL810 FL820

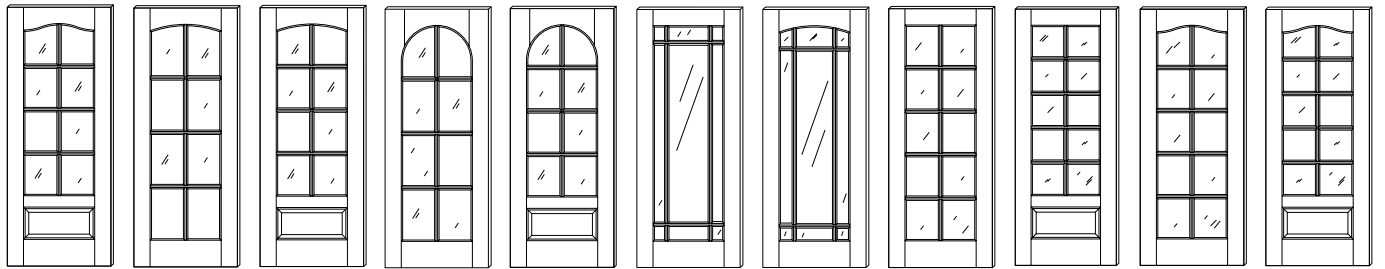

FL821 FL830 FL831 FL840 FL841 FL900 FL901 FL1000 FL1001 FL1010 FL1011

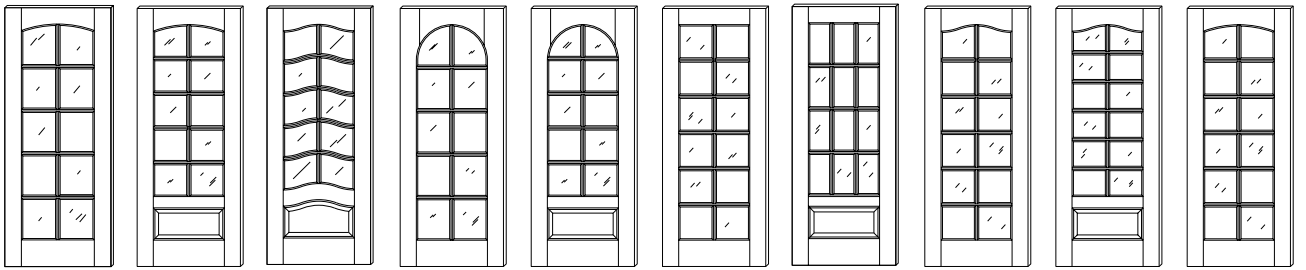

FL1020 FL1021 FL1030 FL1040 FL1041 FL1200 FL1210 FL1220 FL1221 FL1230

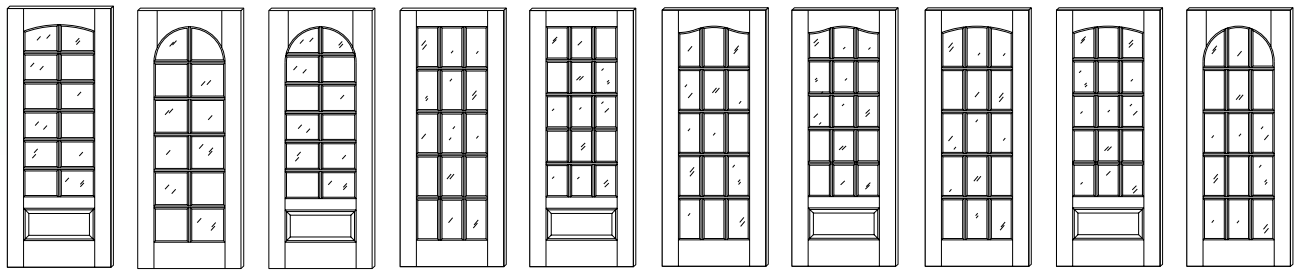

FL1231 FL1240 FL1241 FL1500 FL1501 FL1510 FL1511 FL1520 FL1521 FL1530

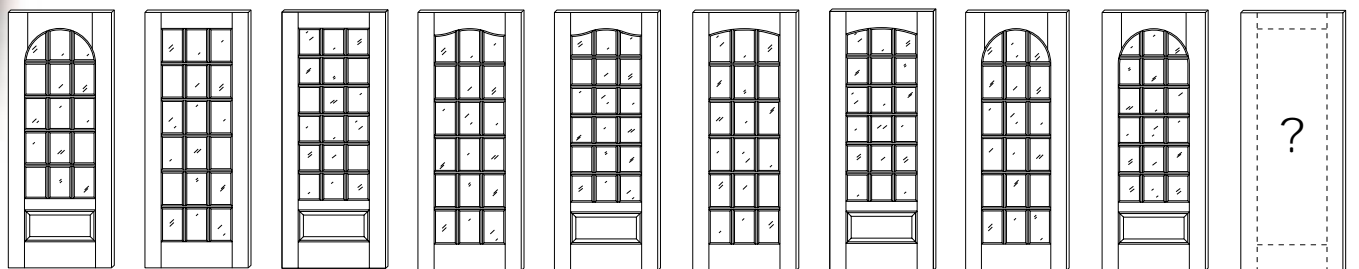

FL1531 FL1800 FL1801 FL1810 FL1811 FL1820 FL1821 FL1830 FL1831 Custom

# PL Series

TruStile's PL Series offers over 40 new door designs. By combining our raised panels with french lites we have created unique door styles that are available for both interior and exterior applications. When ordering be sure to specify your panel and sticking combination, glass type and grade (interior or exterior).

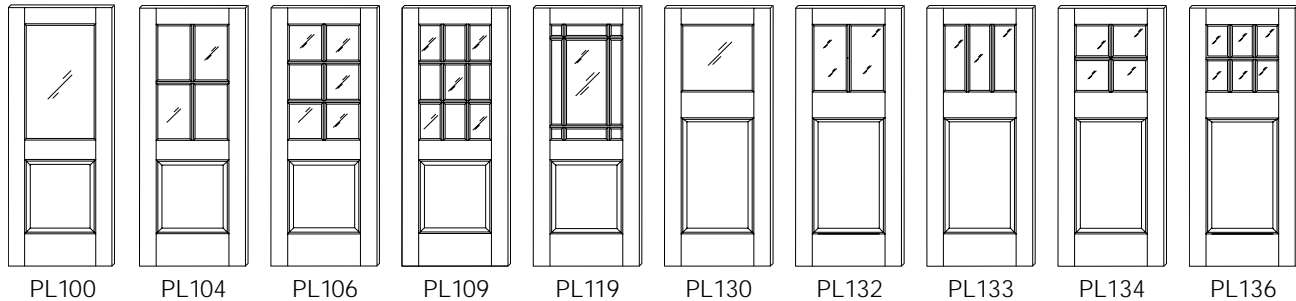

PL100 PL104 PL106 PL109 PL119 PL130 PL132 PL133 PL134 PL136

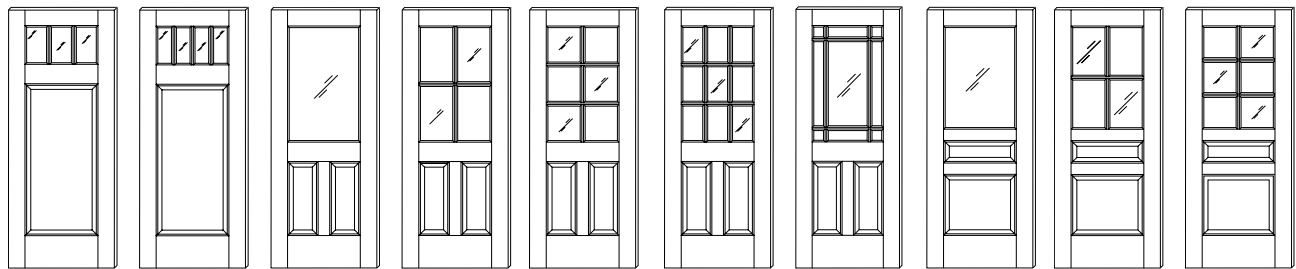

PL143 PL144 PL200 PL204 PL206 PL209 PL219 PL220 PL224 PL226

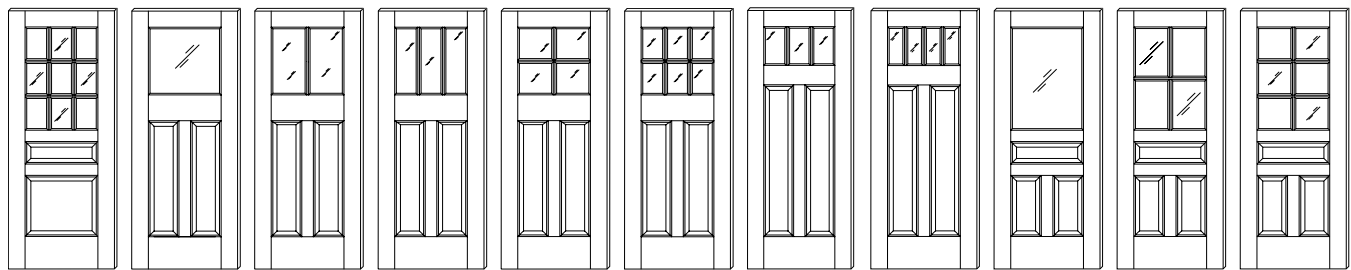

PL229 PL230 PL232 PL233 PL234 PL236 PL243 PL244 PL300 PL304 PL306

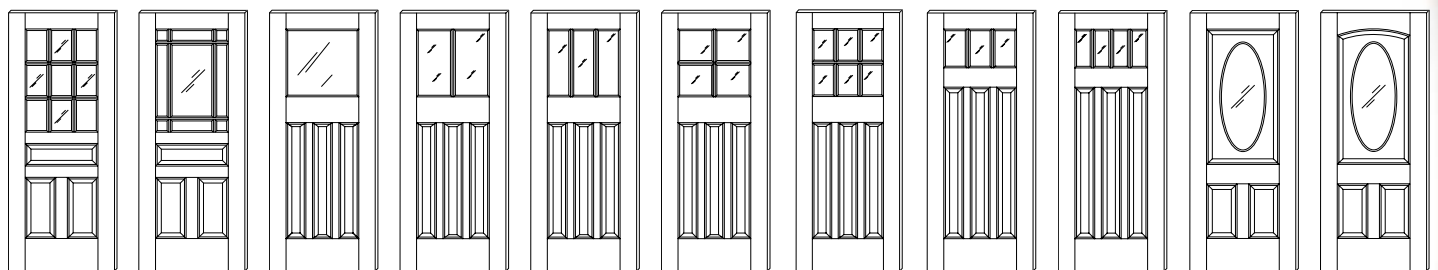

PL309 PL319 PL330 PL332 PL333 PL334 PL336 PL343 PL344 PL360 PL361

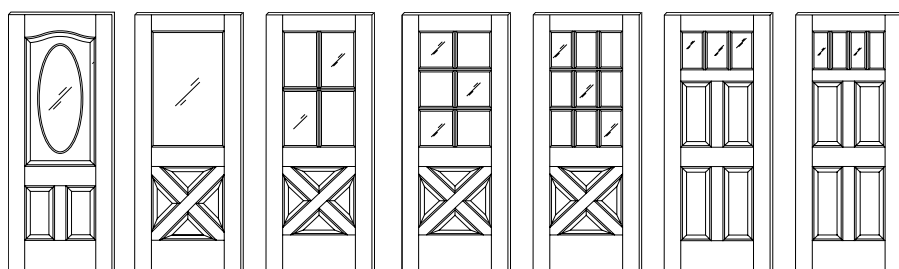

PL362 PL400 PL404 PL406 PL409 PL443 PL444

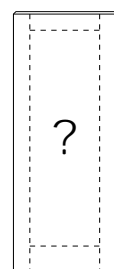

Custom

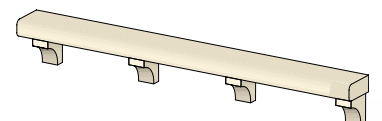

Optional bird ledge is available with many of our PL doors.

Stile Widths (face dimensions):  
4" on doors 30" and under; 5" on doors over 30"

# V-Groove Series

Take a step back with our rustic VG Series. Our square stick and v-groove doors give you the look and feel of tongue and groove plank doors.

When you order a 1-3/8" or 1-3/4" VG door you will receive your choice of our 1/2" or 3/4" C Panel.

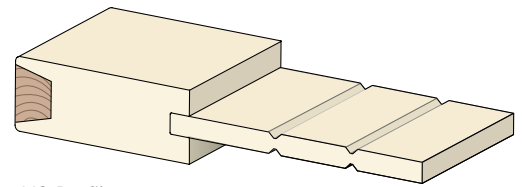

VG Profile

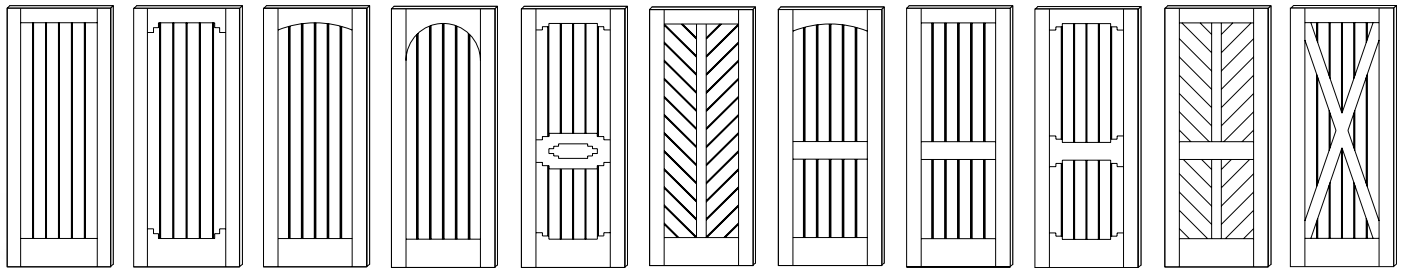

VG1010 VG1020 VG1030 VG1040 VG2000 VG2010 VG2020 VG2030 VG2040 VG4000 VG4010

Stile Widths (face dimensions): 4-1/2" on doors 41" and under; 5-1/2" on doors over 41"

# Tambour Series

For a more contemporary look try our Tambour Series. We combine traditional stile and rail construction with state-of-the-art CNC technology to bring you these sophisticated styles.

With each tambour door style, you have the choice of our half-round or bevel profiles shown below.

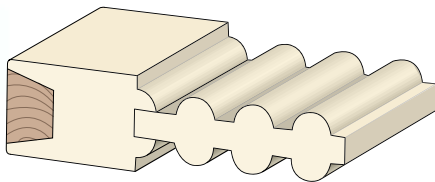

Half-Round Profile

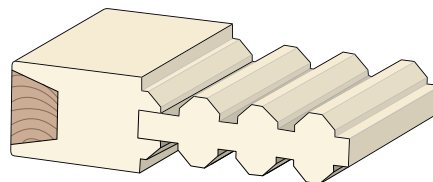

Bevel Profile

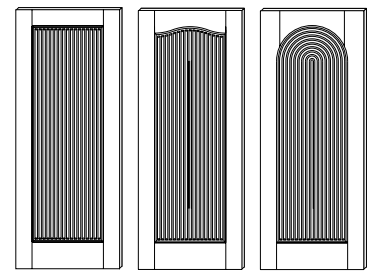

TMB1000 TMB1010 TMB1030

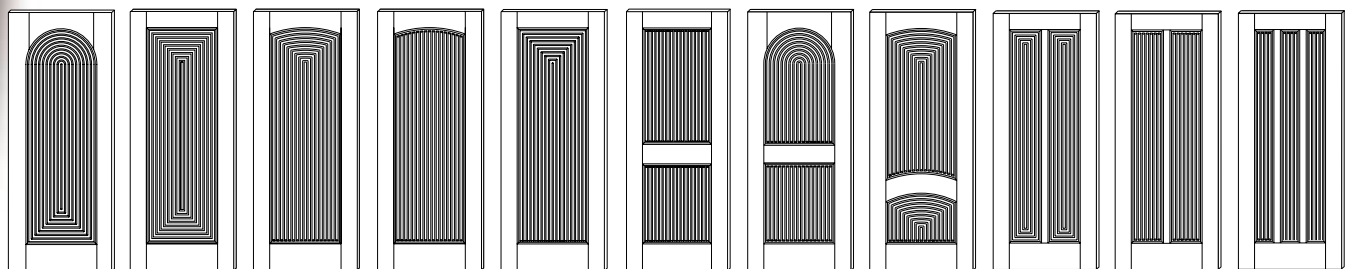

TMB1040 TMB1050 TMB1070 TMB1080 TMB1090 TMB2000 TMB2010 TMB2030 TMB2050 TMB2080 TMB3000

Stile Widths (face dimensions): 5" on all tambours

Our Custom Design Series brings you an eclectic collection of old and new design styles. We combine "old world" craftsmanship with our cutting edge technology to create these custom looks. Whether it is a traditional stile and rail, french lite or sculpted design that you're looking for, you'll find it here.

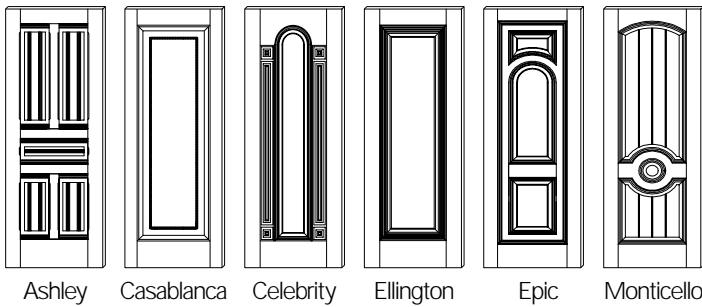

Ashley

## Louver Doors

We offer plantation style louver doors in many of our door designs. You can also replace any square panel with louvers to create a custom look.



LVR2020 TS2030 With Louver Bottom

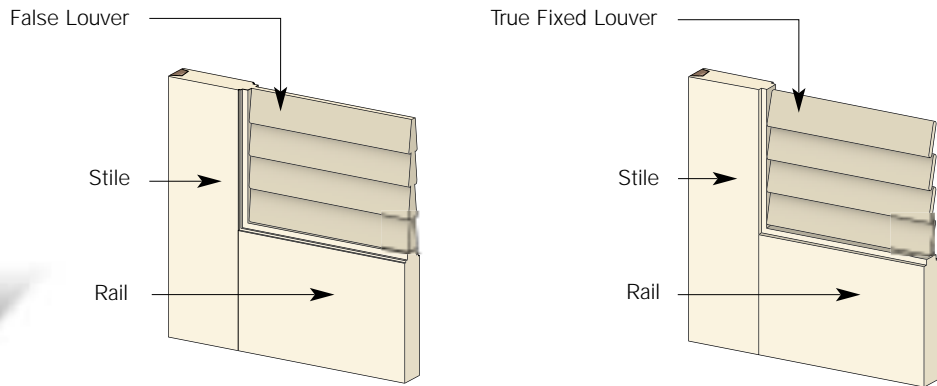

NOTE: Visible louver dimension: 2-1/8".

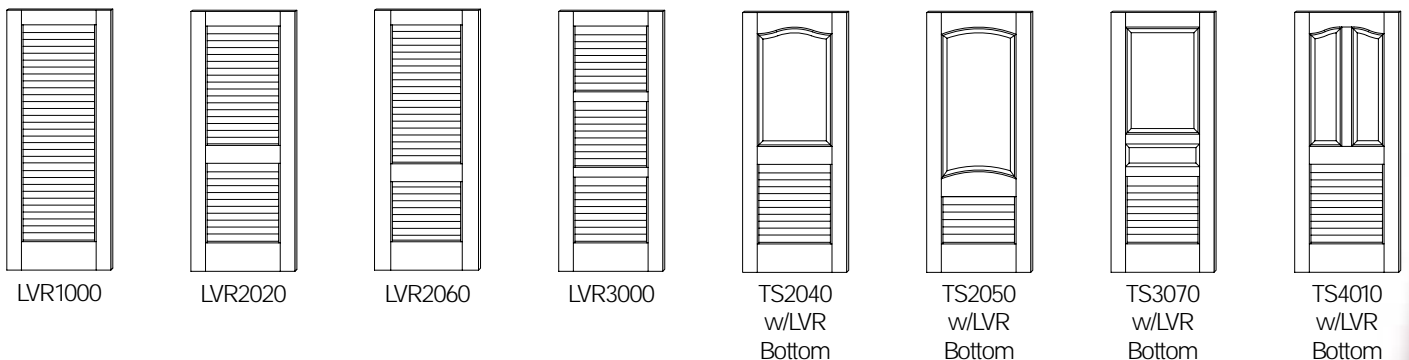

# Options

We understand that sometimes you need something different to create that special opening. That's why we say "no problem" to custom layouts.

## Common Arch Pairs

TS2070 CAP RT

As shown right, Common Arch Pairs (CAP) are available with Square Tops, Arch Tops (AT), Radius Tops (RT) and Elliptical Tops (ET).



## Arch & Radius Tops

We can also provide a custom drop to fit your existing jambs or special needs.



## Pocket and Bypass Doors

Per your request we can include the TopWedge®, our hardwood Wedge®, in the top rail of your pocket or bypass doors. The TopWedge® provides easy hardware installation.

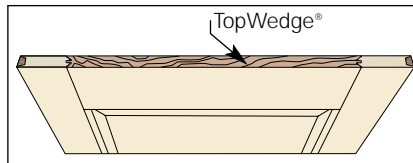

TS3040 Bypass Doors



TS4070 Pocket Doors

## Bifolds



TS8000 4 Leaf Bifold  
TS2020 W/LVR Top  
2 Leaf Bifold

## Transoms

Create a panel or glass transom for your interior or exterior opening. Don't forget you can choose from our glass options shown on pages 8 - 9.

Custom Transom



## Arch, Radius & Elliptical Jambs & Frames

We offer poplar headers separate or with legs. We can also provide doors with custom drops to fit existing jambs. Door stop is available. See your Account Manager for details.

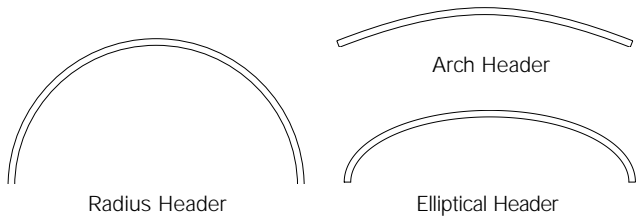

## T-Astragals

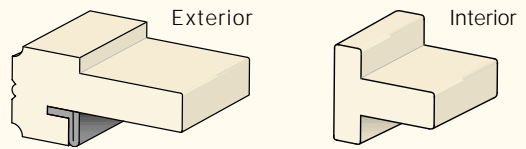

## Other Products

- Shutters
- Clip Corners
- Interior Door Stops
- Exterior Frames (includes weatherstrip)

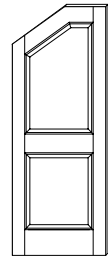

## Custom Program

In addition to our standard panel, sticking and moulding options, we offer a unique custom profile program. This program is excellent for historical matches, remodels or simply for something unique. Please fax us your custom profile (parameters shown below) and we'll bring it to life with our CAD technology.



Custom 2 Panel

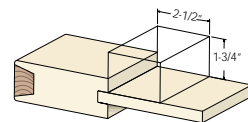
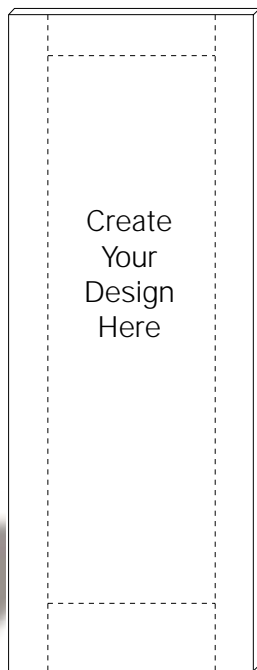

Sample Moulding  
Max Length: 2-1/2"  
Max Thickness: 1-3/4"

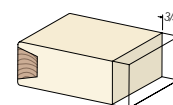
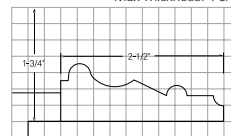

Sample Sticking  
Max Length: 3/4"

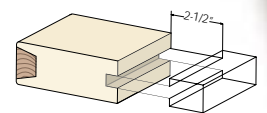
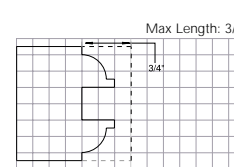

Sample Panel  
Max Length: 2-1/2"  
Max Thickness: 1-3/4"

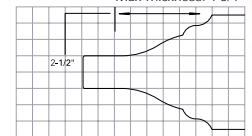

## Historical Matches

TruStile's historical matches combine the beauty and elegance of old-world craftsmanship with the stability and strength of MDF. We offer all the options and accessories you'll need to finish any project. Send us a drawing, a photo, or even an image from a movie and our craftsmen will duplicate every feature with the crisp lines and superior detail of a TruStile MDF Door.



# Sound & Energy Ratings

ACOUSTICAL PERFORMANCE TESTING RESULTS			
<b>Note:</b> Higher STC ratings are available with select hardware. See your Account Manager for details.	STANDARD 1-3/8" DOOR	STANDARD 1-3/4" DOOR	20 MINUTE POSITIVE PRESSURE DOOR
STC RATING (sound transmission class)	31	33	45
DEFICIENCIES (number of deficiencies versus contour curve)	29	30	29
OITC RATING (outdoor/indoor transmission class)	28	30	38
Performance is based mainly on mass. As a comparison, a luan door has a 21 STC rating.			
THERMAL PERFORMANCE TESTING RESULTS			
U-FACTOR (thermal transmittance due to conduction)	.52	.4	N/A
Thermal transmittance (U) was determined in general accordance with ASTM C 1363-97, Standard Test Method the Thermal Performance of Building Assemblies by Means of Hot Box Apparatus.			



TruStile offers 20 through 90 minute 1-3/4" MDF Fire Doors manufactured with our exclusive FireWedge®. The FireWedge® includes an intumescent strip within our Wedge®, which expands and provides a smoke seal when heated. Our Fire Doors are available in hundreds of styles.

	POSITIVE PRESSURE SINGLES	POSITIVE PRESSURE PAIRS
RATING	20, 45, 60, 90	20, 45, 60
STYLES	TS, VG, CD, TMB	TS, VG, CD, TMB

## Recycled Content

Our doors have been tested and certified by SCS for recycled content. TruStile makes every effort to protect our environment.



## Warranty

All TruStile products are manufactured to the highest standards of quality and craftsmanship and backed by our Limited Lifetime Warranty against defects in workmanship and materials.



TS2060

**TRUSTILE®**  
**DOORS INC**

Ph: (888) 286-3931  
Fax: (888) 288-6521  
www.trustile.com

1780 East 66th Avenue  
Denver, Colorado 80229